

SDV40 & SDV70

Sectional Directional Control Valve & Accessory Valve

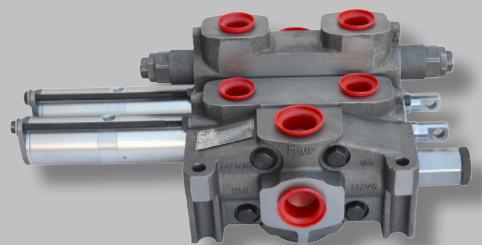
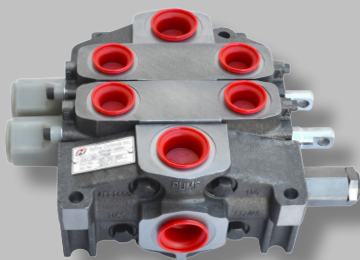
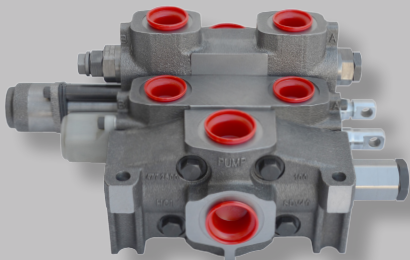
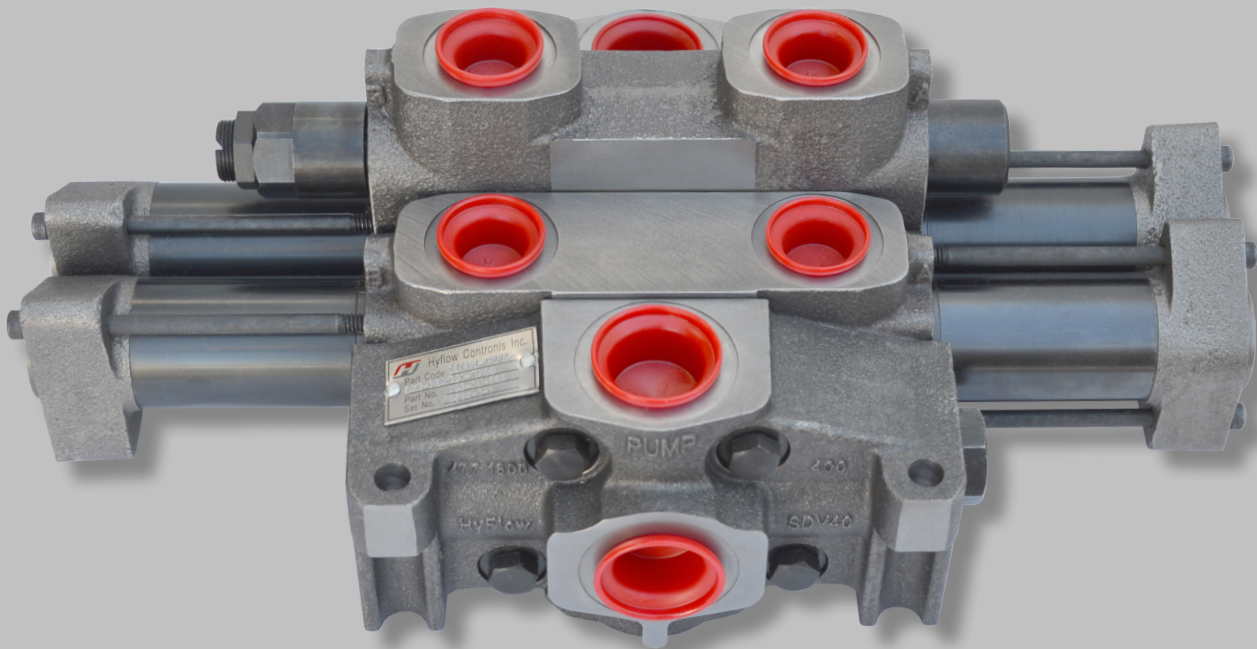

Hyflow Controls

C102018



Hyflow Controls

Please note: All parts supplied are Hyflow Controls®. The use of other manufactures' names, part numbers, descriptions or trademarks is for cross reference and informational purposes only.



Hyflow Controls

Contents

SDV Exploded View	1
SDV40 Valves	3
Dimensional Data	
Coding Table	
• Inlet	
• Mid-Inlet	
• Work Sections	
• Outlets	
SDV70 Valves	14
Dimensional Data	
Coding Table	
• Inlet	
• Mid-Inlet	
• Work Sections	
• Outlets	
Valve Accessories	25
In-Line Accessories	26
Deceleration Valve	27
Flow Control Valve	27
Competitors Interchange Quick Reference	28
Valve Assembly Form	33
Warranty	34

Sectional Directional Control Valve Exploded View

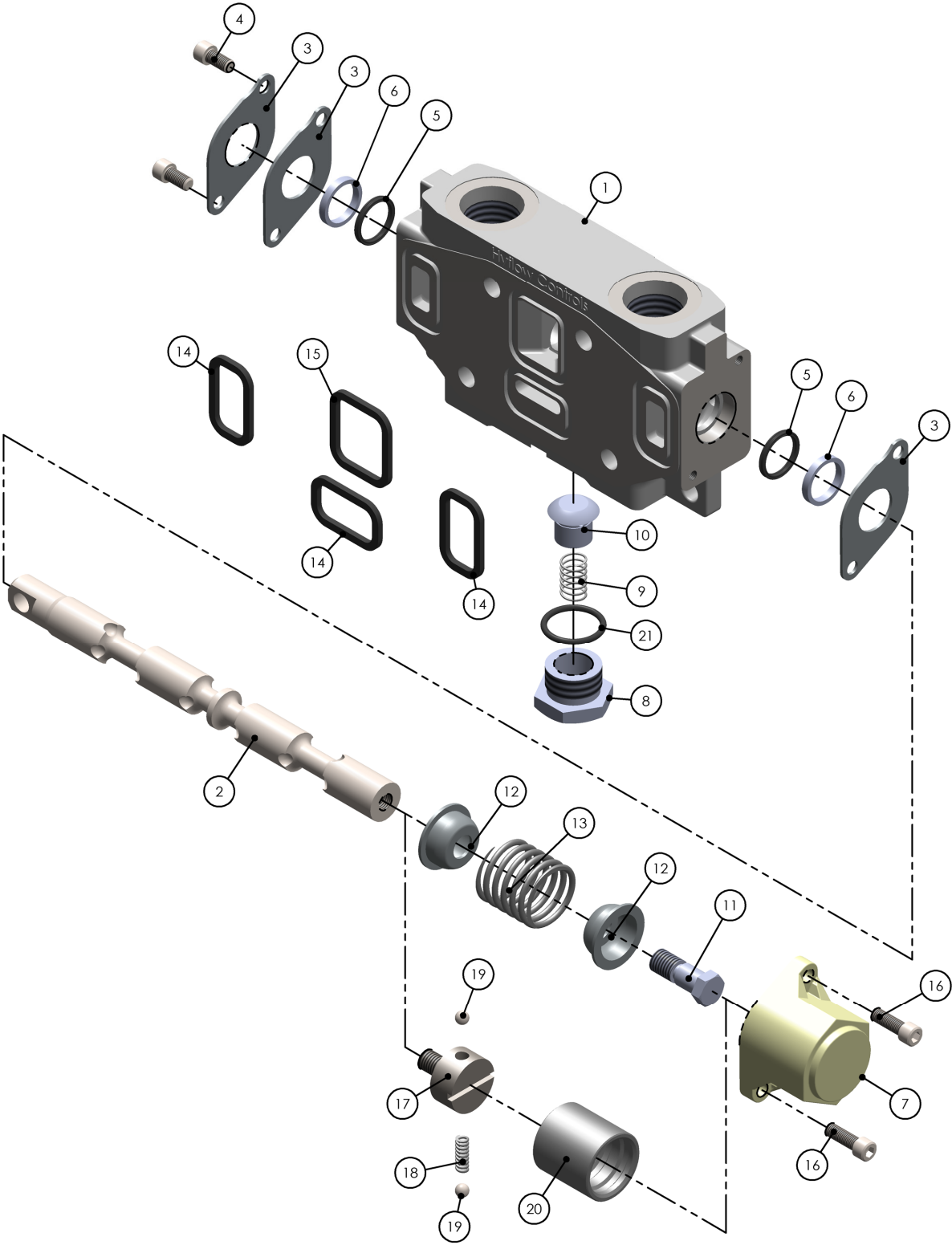

Exploded View Parts List

Item	Part	Qty	SDV40	SDV70
1.	Low-boy work section			
2.	Spool			
3.	Retainer plates	3	491-3183-001	491-3183-005
4.	Retainer plate screws	2	491-2433-015	491-2433-002
5.	Spool seal	2	491-2985-014	491-3887-212
6.	Back up seal	2	491-3681-378	491-3681-426
7.	Back cap	1	441-7000-100	442-6000-100
8.	Check valve hex cap	1	491-1581-044	491-1581-044
9.	Check valve spring	1	491-4581-713	491-4581-713
10.	Check valve poppet	1	491-3481-069	491-3481-069
11.	Stripper bolt	1	491-2432-022	491-2432-021
12.	Spring guides	2	491-2642-045	491-2642-013
13.	Centering spring	1	491-4581-608	491-4581-633
14.	Section seals - (3 pcs)	3	491-3881-206	491-3881-200
15.	Section seal - (1 pc)	1	491-3881-200	491-3881-403
16.	Back cap screws	2	491-2433-020	491-2433-009
17.	Detent poppet retainer	1	491-3583-008	491-3583-006
18.	Detent spring	1	491-4581-130	491-4581-015
19.	Detent balls	2	491-1282-010	491-1282-009
20.	Detent sleeve	1	491-4283-015	491-4283-008
21.	Check valve o-ring	1	491-3881-204	491-3881-204

SDV40

Technical Data

Construction	Sectional
Circuit	Parallel/Open Center
Capacity	SDV40: 40gpm nominal
Max Operate Pressure	2500psi NPT - 3500psi SAE ports only with thru hole outlet
Max Tank Pressure	150psi
Filtration	25 Micron
Spool Force	50lbs Maximum
Temperature	-20° to 200°F(-29° to 93°C)
Seal Type	Buna-N
Relief Valve	Differential type, screw adjustable
Material	Compacted graphite, high strength iron alloy

Valve Features

- Built-in, full-flow relief valves
- Parallel/Open center standard
- Spool changeover capability for right or left hand assemblies (left hand standard)
- Transition load checks to prevent load shift between spool positions (cylinder spool only)
- Manual, hydraulic, or pneumatic operation
- Sectional construction for maximum flexibility
- Low internal pressure drop
- Work sections are 100% pre-assembled and pre-tested before shipping

Cross Reference

Hyflow Controls®	Parker®	Muncie®
SDV40	DVA/DVG20, VA/VG20, A20,V40,V42 and 25P	60V

SDV40 is 100% compatible with DVA/DVG20 and 60V

Approximate Weight (Lbs)

Parts	Inlet	Outlet	PB Outlet	Work Section	Hi-Boy Section
SDV40	9.5	6.8	7.7	9.6	12.2

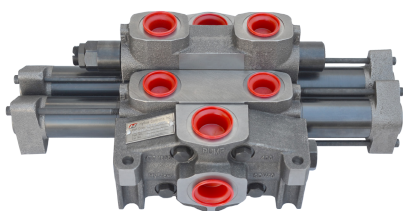

Hydraulic control

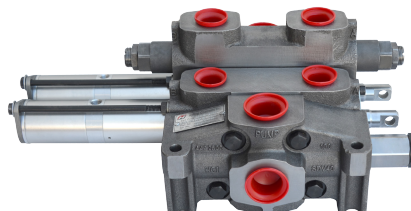

Air-shift



Manual

Valve Assembly Schematic

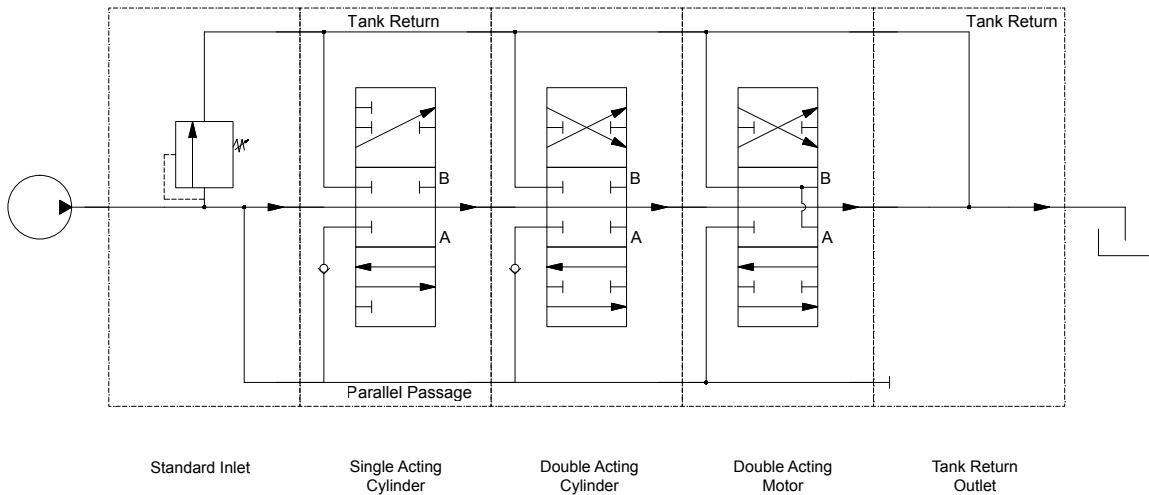

Performance - Pressure Drops vs. Flow Rates

(all tests run at 100SSu and 120°F)

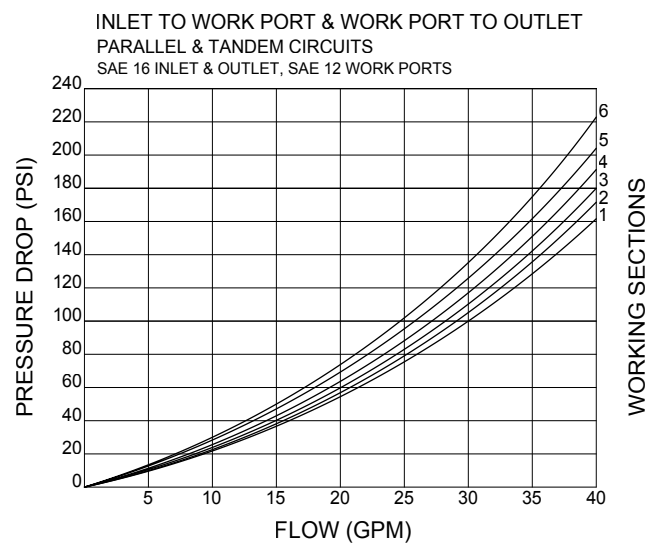
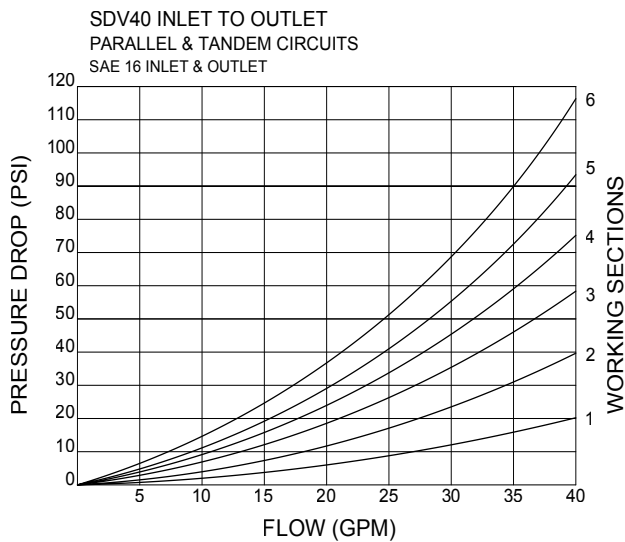

Dimensional Data

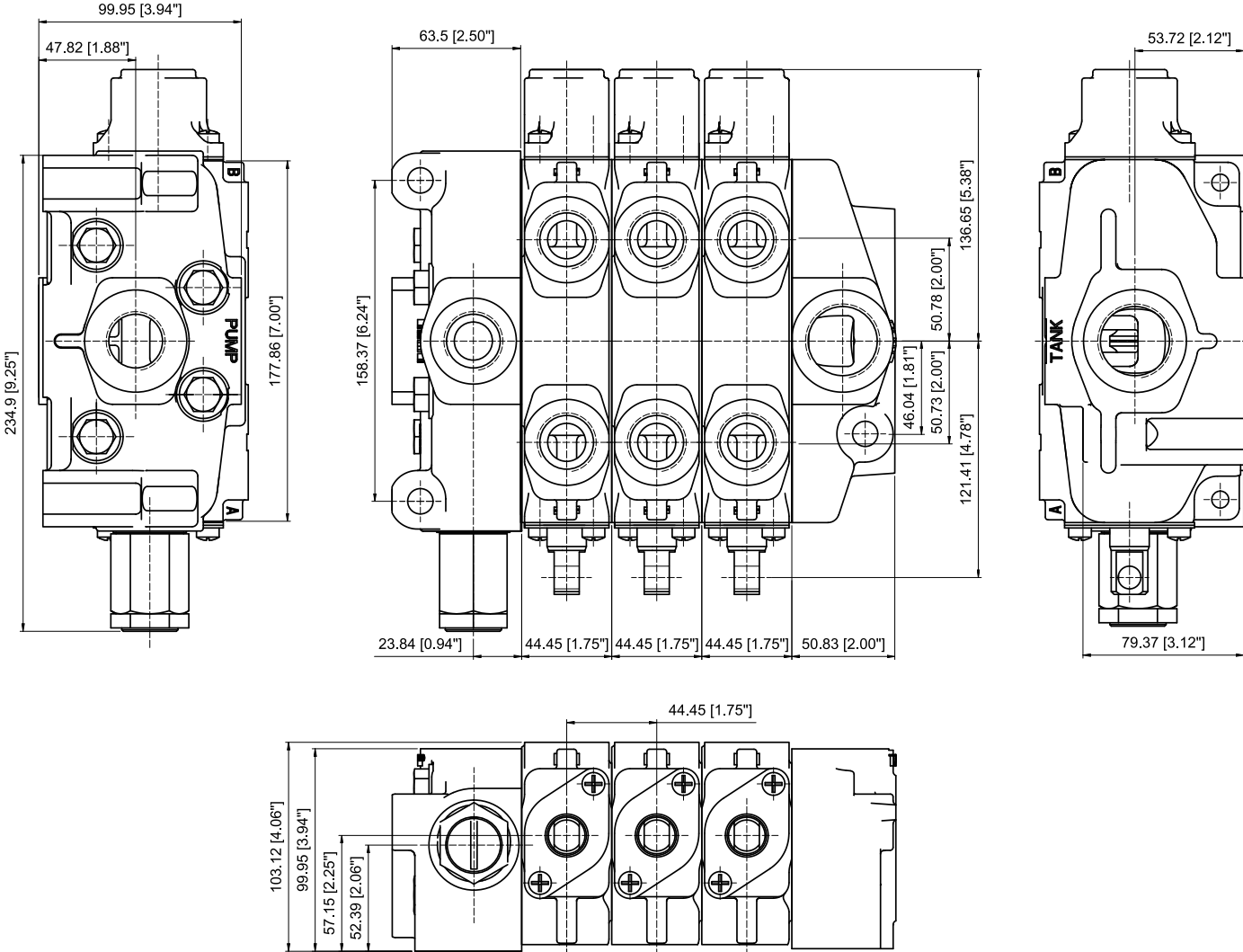

Inlet and Mid-Inlet Coding Table

SDV40 - A - 88 - A

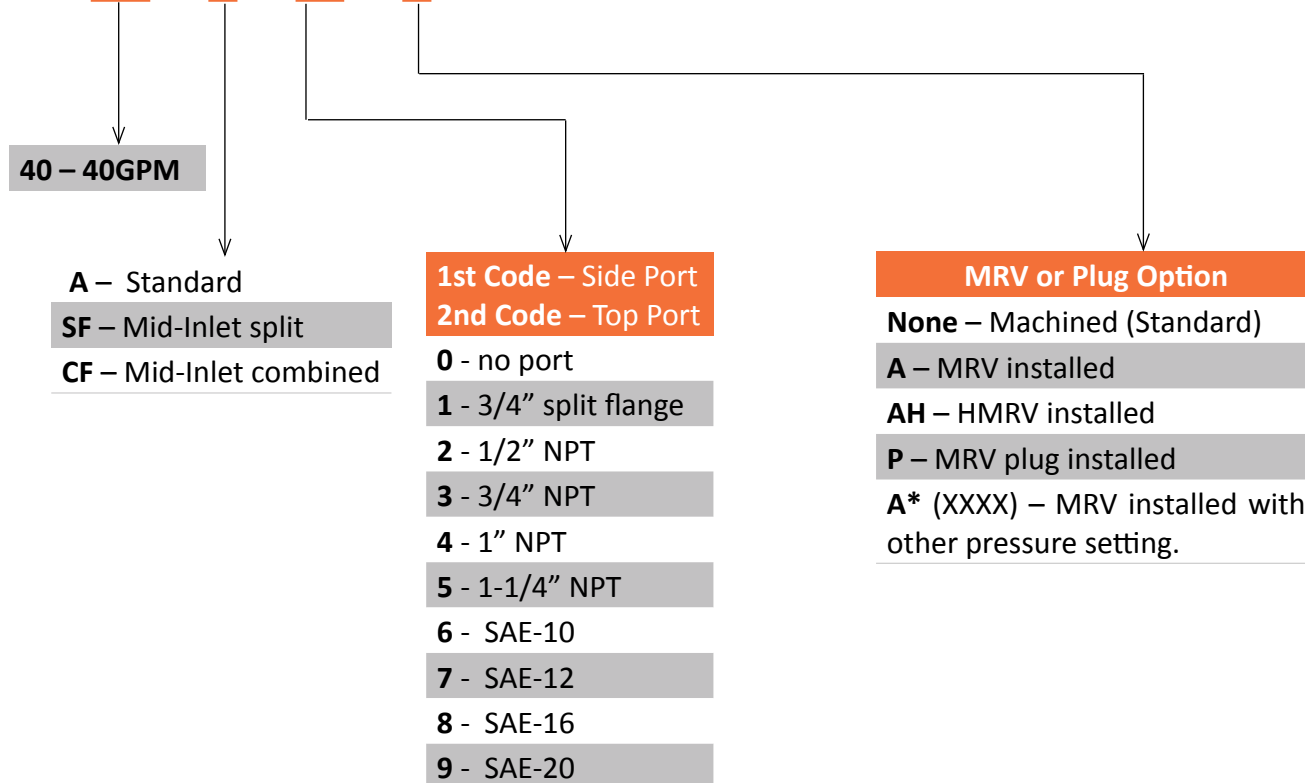

Standard

Part Number	Replacement for	Replacement for	Side Port	Top Port
SDV40-A44	347-9175-001		1" NPT	1" NPT
SDV40-A77		347-9175-004	SAE-12	SAE-12
SDV40-A88	347-9175-002		SAE-16	SAE-16

Includes plastic port plugs

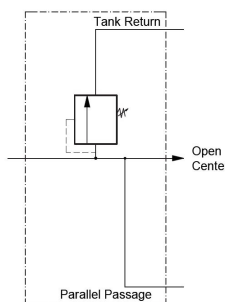

Schematic with MRV

Mid-Inlet - Machined for MRV or MRVP.

Combined Flow - Combines primary & secondary pump flows for faster operating speed of downstream functions.

Part Number	Replacement for	Top Port
SDV40-CFA30	347-9174-003	3/4" NPT
SDV40-CFA70	347-9174-004	SAE-12

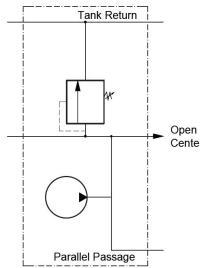

Schematic with MRV

Split Flow - Separates primary and secondary pump flows. One valve bank operates like two.

Part Number	Replacement for	Top Port
SDV40-SFA30	347-9174-001	3/4" NPT
SDV40-SFA70	347-9174-002	SAE-12

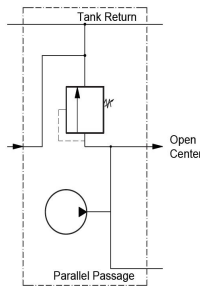

Schematic with MRV



Main Relief Valves (MRV) Inlet - Mid-inlets differential type, screw adjustable



Part Number	Replacement for	Description
SDV40-MRV	391-1873-001	2000psi, adj. 800-2500psi
SDV40-MRV-2200	391-1873-001	2200psi, adj. 800-2500psi
SDV40-MRV-2500	391-1873-001	2500psi, adj. 800-2500psi
SDV40-HMRV	391-1873-128	3000psi, adj. 2500-3500psi
SDV40-HMRV-2600	391-1873-128	2600psi, adj. 2500-3500psi
SDV40-MRVP	391-1873-002	Main relief valve plug with seal washer

MRV and MRVP torque 75 ft. lbs. (900 in. lbs.)

Work Section Coding Table

SDV40- H D A 7 33(2500/2500) *

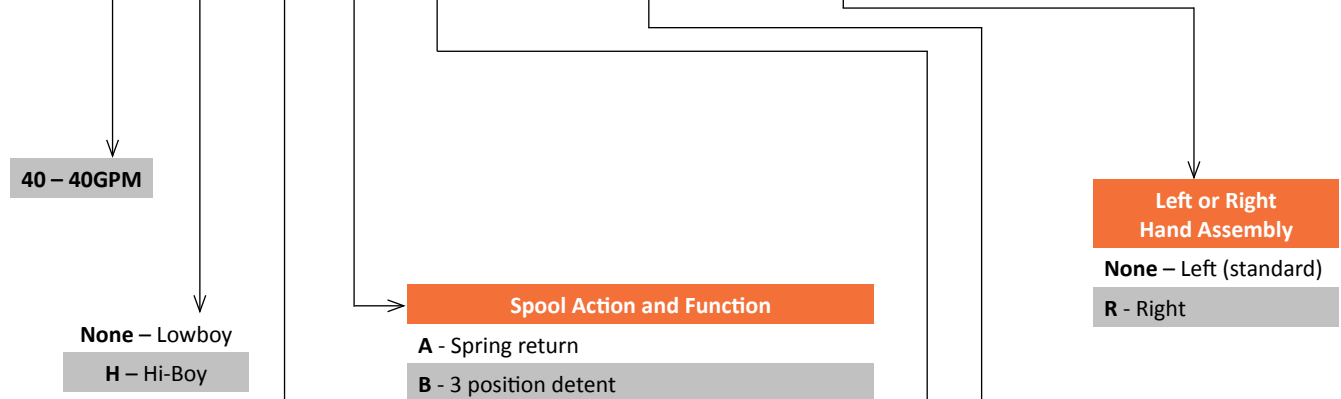

- Spool Action and Function**
- A - Spring return
 - B - 3 position detent
 - V - Single ended air shift, metering
 - VA - Single ended air shift, on/off
 - X - Hydraulic remote control, metering

Spool Function + Circuit		Symbol
S	Parallel Single acting Cylinder spool, B port	
D	Parallel Double acting Cylinder spool	
WHD	Series Double acting Cylinder spool Hi-boy only	 Spool functions symbols for: D and WHD.
M	Parallel Double acting Motor spool	
WHM	Series Double acting Motor spool Hi-boy only	 Spool functions symbols for: M and WHM.

- A & B Port Size:**
- 0 - no port
 - 1 - 3/4" split flange
 - 2 - 1/2" NPT
 - 3 - 3/4" NPT
 - 4 - 1" NPT
 - 5 - SAE-8
 - 6 - SAE-10
 - 7 - SAE-12
 - 8 - SAE-16
 - 9 - SAE-20

- Hi-Boy only**
- Port accessory relief valve
- 1st code - A port
 - 2nd code - B port
 - None or 5 - machined with plastic port covers (standard)
 - 0 - Not machined
 - 1 - PRVAC - relief valve with anti-cavitation
 - 2 - AC - anti-cavitation only, screw adj.
 - 3 - PRVS relief valves, screw adj.
PRVS1 - 1000psi
PRVS2 - 2000psi
PRVS3 - 2500psi
 - To specify pressure setting use (XXXX) format. Example: 3 (2000)
 - 6 - PPRVS - pilot pressure relief
 - 9 - PRVP - port relief plug

When specifying relief valve pressure setting use (XXXX) format.
Example: SDV40-HDA7
33(2500/2500)

Standard Work Sections

Part Number SDV40	Replacement for	3 Way 3 Position hold in neutral	4 Way 3 Position hold in neutral	4 Way 3 Position float in neutral	Port Size	Spring Return	3 Position Detent	Metering Hydraulic Remote	Metering Air Shift	On/Off Air Shift
DA3	347-9172-002		X		¾"NPT	X				
DA7	347-9172-003		X		SAE-12	X				
DB3	347-9172-026		X		¾"NPT		X			
DB7	347-9172-027		X		SAE-12		X			
DV3	347-9172-033		X		¾"NPT				X	
DV7	347-9172-034		X		SAE-12				X	
DVA3			X		¾"NPT					X
DVA7			X		SAE-12					X
DX3	347-9172-043		X		¾"NPT			X		
DX7	347-9172-044		X		SAE-12			X		
MA3	347-9172-005			X	¾"NPT	X				
MA7	347-9172-006			X	SAE-12	X				
MB3	347-9172-039			X	¾"NPT		X			
MB7	347-9172-040			X	SAE-12		X			
MV3	347-9172-136			X	¾"NPT				X	
MV7	347-9172-137			X	SAE-12				X	
MVA3				X	¾"NPT					X
MVA7				X	SAE-12					X
MX3	347-9172-062			X	¾"NPT			X		
MX7	347-9172-063			X	SAE-12			X		
SA3	347-9171-002	X			¾"NPT	X				
SA7	347-9171-003	X			SAE-12	X				
SB3	347-9171-026	X			¾"NPT		X			
SB7	347-9171-027	X			SAE-12		X			
SV3	347-9101-129	X			¾"NPT				X	
SV7	347-9171-018	X			SAE-12				X	
SVA3		X			¾"NPT					X
SVA7		X			SAE-12					X
SX3		X			¾"NPT	X		X		
SX7	347-9101-161	X			SAE-12	X		X		

Hi-Boy Work Sections

Part Number SDV40	Replacement for	3 Way 3 Position hold in neutral	4 Way 3 Position hold in neutral	4 Way 3 Position float in neutral	Port Size	Spring Return	3 Position Detent	Metering Hydraulic Remote	Metering Air Shift	On/Off Air Shift
HDA3	347-9172-008		X		¾"NPT	X				
HDA7	347-9172-009		X		SAE-12	X				
HDA7-PA			X		SAE-12	X				
HDA7-PB			X		SAE-12	X				
HDB3	347-9172-017		X		¾"NPT		X			
HDB7	347-9172-018		X		SAE-12		X			
HDV3	347-9172-024		X		¾"NPT				X	
HDV7	347-9172-025		X		SAE-12				X	
HDVA3			X		¾"NPT					X
HDVA7			X		SAE-12					X
HDX3	347-972-045		X		¾"NPT			X		
HDX7	347-9172-046		X		SAE-12			X		
HMA3	347-9172-011			X	¾"NPT	X				
HMA7	347-9172-012			X	SAE-12	X				
HMB3	347-9172-177			X	¾"NPT		X			
HMB7	347-9172-178			X	SAE-12		X			
HMV3	347-9172-126			X	¾"NPT				X	
HMV7	347-9172-127			X	SAE-12				X	
HMVA3				X	¾"NPT					X
HMVA7				X	SAE-12					X
HMX3	347-9172-072			X	¾"NPT			X		
HMX7	347-9172-073			X	SAE-12			X		
HSA3	347-9171-005	X			¾"NPT	X				
HSA7	347-9171-006	X			SAE-12	X				
HSB3	347-9171-010	X			¾"NPT		X			
HSB7	347-9171-012	X			SAE-12		X			
HSV3	347-9171-011	X							X	
HSV7		X							X	
HSVA3		X								X
HSVA7		X								X
HSX3		X			¾"NPT	X		X		
HSX7		X			SAE-12	X		X		

Outlet - Coding Table

SDV40 - TR - 8 8

40 - 40GPM

TR - Tank return
 PB - Power beyond
 TTR - Thru hole
 TPB - Thru hole

1st Code - Side Port
 2nd Code - Top Port

0 - no ports
 1 - 3/4" split flange
 2 - 1/2" NPT
 3 - 3/4" NPT
 4 - 1" NPT
 5 - 1-1/4" NPT
 6 - SAE-10
 7 - SAE-12
 8 - SAE-16
 9 - SAE-20



Tank Return

Part Number	Replacement for	Side Port	Top Port
SDV40-TR44	347-9176-001	1"NPT	1"NPT
SDV40-TR50	347-0176-501	1-1/4" NPT	no port
SDV40-TR88	347-9176-002	SAE-16	SAE-16
*SDV40-TTR88	347-9176-007	SAE-16	SAE-16
*SDV40-TTR90	347-9176-024	SAE-20	no port

Note: * For 3500psi application

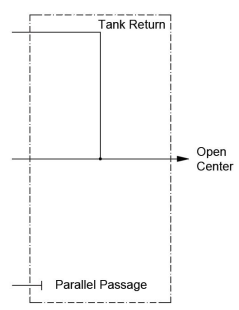

Power Beyond

Part Number	Replacement for	Side Port LP	Side Port HP	Top Port LP	Top Port HP
SDV40-PB08	347-9176-005	no port	no port	SAE-16	SAE-16
SDV40-PB44	347-9176-003	1"NPT	1"NPT	1"NPT	1"NPT
SDV40-PB80	347-9176-004	SAE-16	SAE-16	no port	no port
SDV40-PB88	347-9176-007	SAE-16	SAE-16	SAE-16	SAE-16
*SDV40-TPB88	347-9176-008	SAE-16	SAE-16	SAE-16	SAE-16

Note: * For 3500psi application

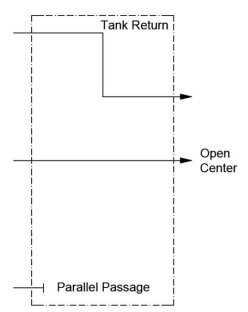

Stud Kits



Part Number	Replacement for
SDV40-SK-1	391-1873-045
SDV40-SK-2	391-1873-046
SDV40-SK-3	391-1873-047
SDV40-SK-4	391-1873-048
SDV40-SK-5	391-1873-049
SDV40-SK-6	391-1873-050
SDV40-SK-7	391-1873-051
SDV40-SK-8	391-1873-052

TSK studs - torque 42ft.lbs. (504in. lbs.)

Thru Hole Stud Kits



Part Number	Replacement for
SDV40-TSK-1	391-1873-129
SDV40-TSK-2	391-1873-130
SDV40-TSK-3	391-1873-131
SDV40-TSK-4	391-1873-132
SDV40-TSK-5	391-1873-133
SDV40-TSK-6	391-1873-134
SDV40-TSK-7	391-1873-135
SDV40-TSK-8	391-1873-136

TSK studs - torque 42ft.lbs. (504in. lbs.)

Work Section Spool Actuator Kits

Part Number	Replacement for	Function
SDV40-K-100	391-1873-019	Spring return
SDV40-K-101	391-1873-020	3 position detent
SDV40-K-109	391-1873-173	Metering hyd remote control
SDV40-K-113	391-1873-206	Metering air shift
SDV40-K-113A		Airshift on/off

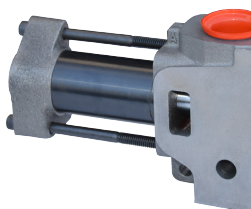

**Metering Hydraulic
Remote Control Kit**



**Metering
Air-Shift Kit**

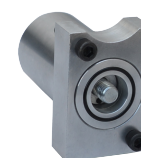

**Air Shift
ON/OFF**

Spools

Part Number	Replacement for	Description
SDV40-SPL-1	391-1873-067	4 way/3 position, hold in neutral
SDV40-SPL-3	391-1873-071	4 way/3 position, float in neutral
SDV40-SPL-5	391-1873-075	3 way/3 position, hold in neutral

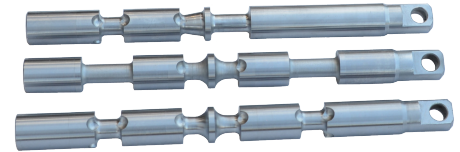

Seal Kits

Part Number	Replacement for	Kit	Kit Contains
SDV40-K-1	391-2873-035	Work section assembly kit	4 section seals
SDV40-K-2	391-1873-036	Work section repair kit	7 seals & 2 spool support rings

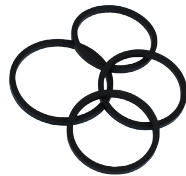

K-1

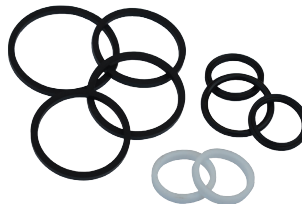

K-2

Handle Assembly - includes linkage kit.

H style handles are for Hi-Boy sections with port relief valve on the handle side.

Part Number	Replacement for	Handle Length	Handle Style
SDV40-H-4	391-1873-094	8"	Standard
SDV40-H-6	391-1873-061	6"	H
SDV40-H-8	391-1873-062	8"	H
SDV40-H-10	391-1873-063	10"	H



SDV70

Technical Data

Construction	Sectional
Circuit	Parallel/Open Center
Capacity	SDV70: 70gpm nominal
Max Operate Pressure	2500psi NPT - 3500psi SAE ports only with thru hole outlet
Max Tank Pressure	150psi
Filtration	25 Micron
Spool Force	50lbs Maximum
Temperature	-20° to 200°F(-29° to 93°C)
Seal Type	Buna-N
Relief Valve	Differential type, screw adjustable
Material	Compacted graphite, high strength iron alloy

Valve Features

- Built-in, full-flow relief valves
- Parallel/Open center standard
- Spool changeover capability for right or left hand assemblies (left hand standard)
- Transition load checks to prevent load shift between spool positions (cylinder spool only)
- Manual, hydraulic or pneumatic operation
- Sectional construction for maximum flexibility
- Low internal pressure drop
- Work sections are 100% pre-assembled and pre-tested before shipping

Cross Reference

Hyflow Controls®	Parker®	Muncie®
SDV70	DVA/DVG35 VA/VG35	60V

SDV70 is 100% compatible with DVA/DVG35 and 60V

Approximate Weight (Lbs)

Parts	Inlet	Outlet	PB Outlet	Work Section	Hi-Boy Section
SDV70	13.8	10.7	11.6	13.7	19.0

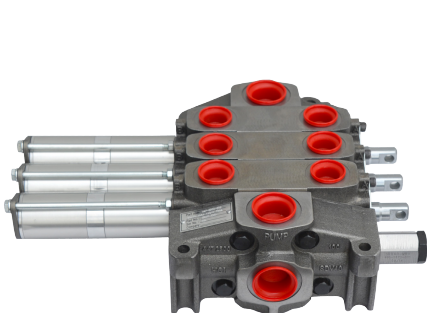

Metering air shift

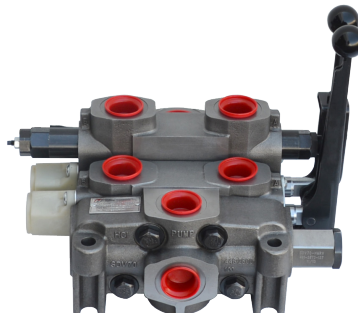

Manual handle

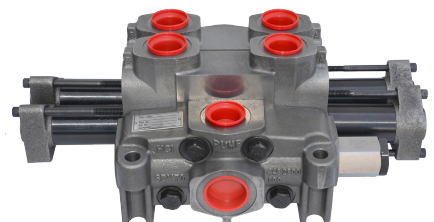

Metering hydraulic remote control

Valve Assembly Schematic

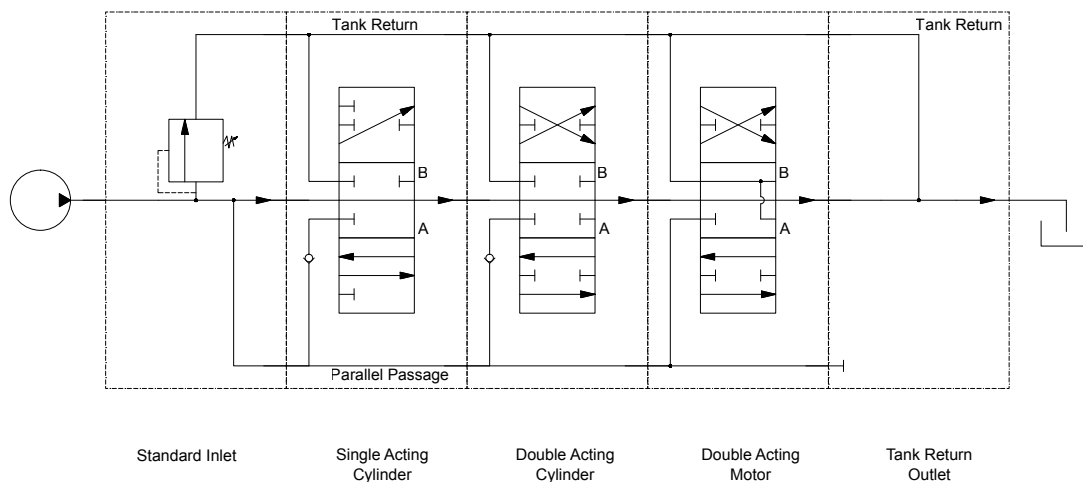

Performance - Pressure Drops vs. Flow Rates

(all tests run at 100SSu and 120°F)

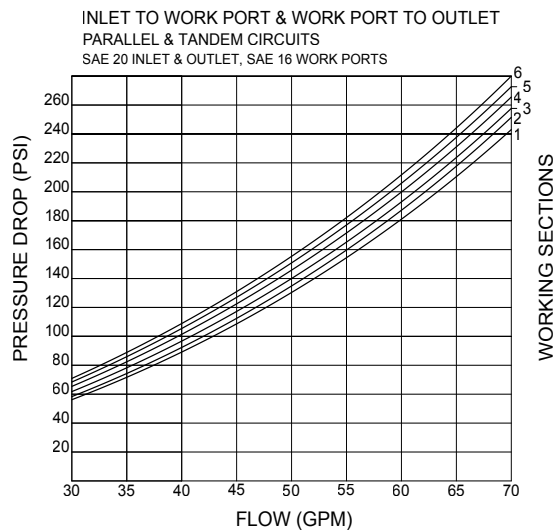
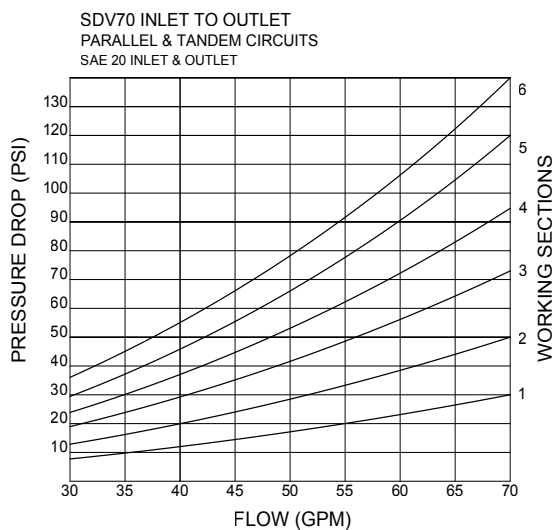

Dimensional Data

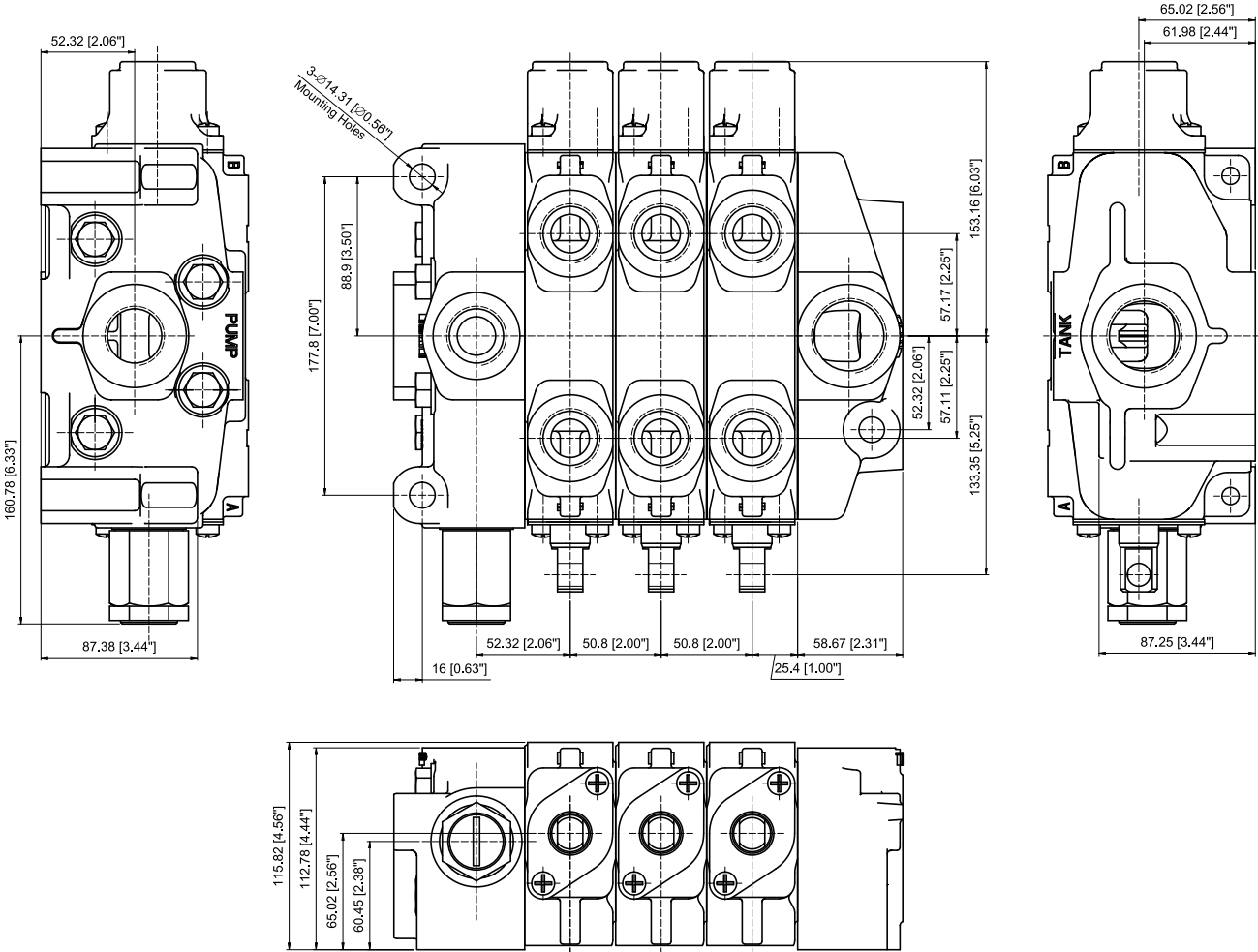

Inlet and Mid-Inlet Coding Table

SDV70- A - 9 - 8 - A2

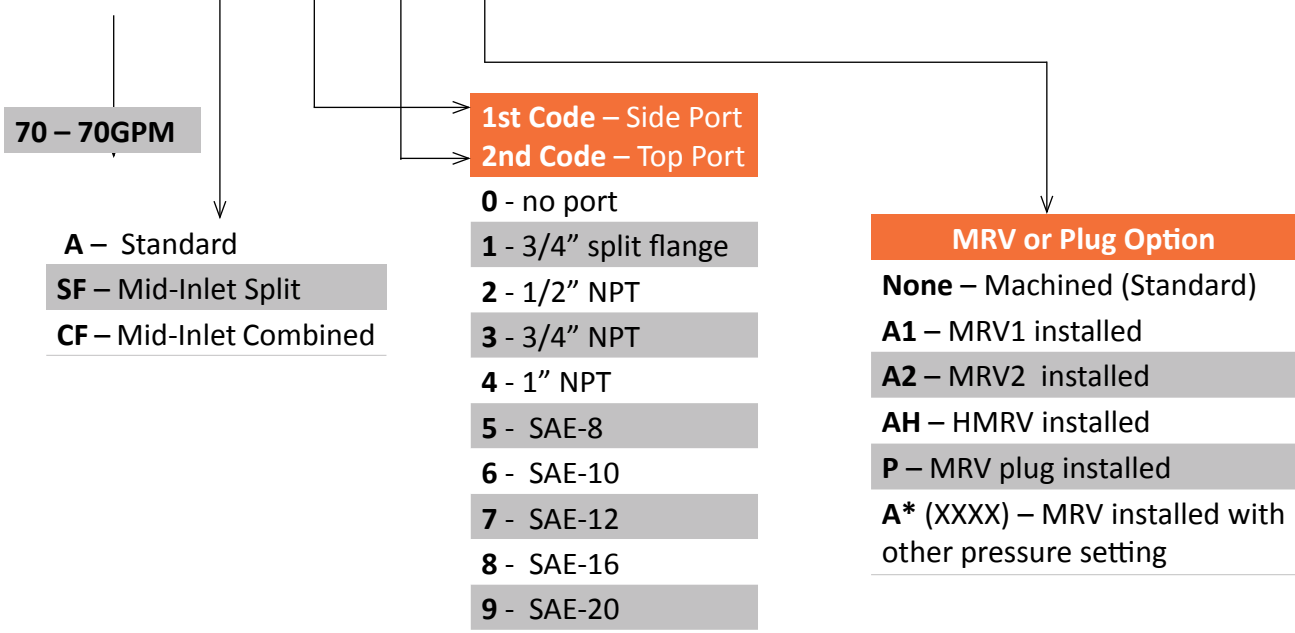

Standard

Part Number	Replacement for	Replacement for	Side Port	Top Port
SDV70-A44	348-9175-001		1" NPT	1" NPT
SDV70-A88	348-9175-005	348-9175-008	SAE-16	SAE-16
SDV70-A98	348-9175-002	348-9175-004	SAE-20	SAE-16

Includes plastic port plugs

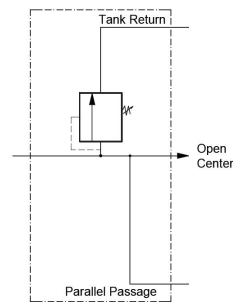

Schematic with MRV

Mid-Inlet - Machined for MRV or MRVP.

Combined Flow - Combines primary & secondary pump flows for faster operating speed of downstream functions.

Part Number	Replacement for	Top Port
SDV70-CFA40	348-9174-003	1" NPT
SDV70-CFA80	348-9174-004	SAE-16

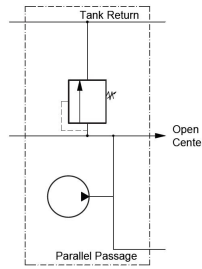

Schematic with MRV

Split Flow - Separates primary and secondary pump flows. One valve bank operates like two.

Part Number	Replacement for	Top Port
SDV70-SFA40	348-9174-001	1" NPT
SDV70-SFA80	348-9174-002	SAE-16

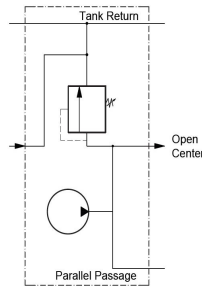

Schematic with MRV



Main Relief Valves (MRV) Inlet - Mid-inlets differential type, screw adjustable



Part Number	Replacement for	Description
SDV70-MRV1	391-1873-003	1500psi, adj. 800-2000psi adjustable
SDV70-MRV2	391-1873-004	2500psi, adj. 2000-2500psi adjustable
SDV70-HMRV	391-1873-137	3000psi, adj.2000-3500psi adjustable
SDV70-MRVP	391-1873-005	Main relief valve plug with seal washer

MRV and MRVP torque 75 ft. lbs. (900 in. lbs.)

SDV70 Work Section Coding Table

SDV70- H D A 8 33(2500/2500) *

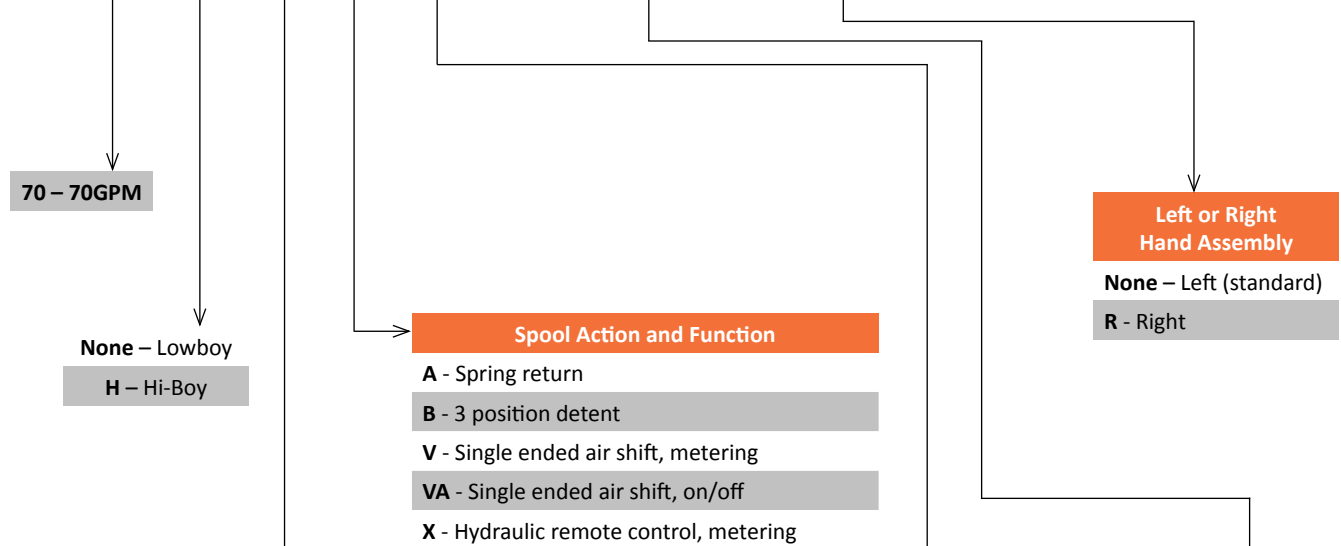

Spool Function + Circuit		Symbol
S	Parallel Single acting Cylinder spool, B port	
D	Parallel Double acting Cylinder spool	
WHD	Series Double acting Cylinder spool Hi-boy only	Spool functions symbols for: D, WHD and TD
M	Parallel Double acting Motor spool	
WHM	Series Double acting Motor spool Hi-boy only	Spool functions symbols for: M, WHM, and TM

- Spool Action and Function**
- A** - Spring return
 - B** - 3 position detent
 - V** - Single ended air shift, metering
 - VA** - Single ended air shift, on/off
 - X** - Hydraulic remote control, metering

- Left or Right Hand Assembly**
- None** - Left (standard)
 - R** - Right

- A & B Port Size:**
- 0** - no port
 - 1** - 3/4" split flange
 - 2** - 1/2" NPT
 - 3** - 3/4" NPT
 - 4** - 1" NPT
 - 5** - SAE-8
 - 6** - SAE-10
 - 7** - SAE-12
 - 8** - SAE-16
 - 9** - SAE-20

- Hi-Boy only**
- Port accessory relief valve
- 1st code** - A port
 - 2nd code** - B port
 - None or 5** - machined with plastic port covers (standard)
 - 0** - Not machined
 - 1** - PRVAC - relief valve with anti-cavitation
 - 2** - AC - anti-cavitation only, screw adj.
 - 3** - PRVS relief valves, screw adj.
 - PRVS1 - 1000psi
 - PRVS2 - 2000psi
 - PRVS3 - 2500psi
 To specify pressure setting use (XXXX) format. Example: 3 (2000)
 - 6** - PPRVS - pilot pressure relief
 - 9** - PRVP - port relief plug

When specifying relief valve pressure setting use (XXXX) format. Example: SDV70-HDA8 33(2500/2500)

Standard Work Sections

Part Number SDV70	Replacement for	3 Way 3 Position hold in neutral	4 Way 3 Position hold in neutral	4 Way 3 Position float in neutral	Port Size	Spring Return	3 Position Detent	Metering Hydraulic Remote	Metering Air Shift	On/Off Air Shift
DA4	348-9172-002		X		1" NPT	X				
DA8	348-9172-003		X		SAE-16	X				
DB4	348-9172-022		X		1" NPT		X			
DB8	348-9172-023		X		SAE-16		X			
DV4	348-9172-029		X		1" NPT				X	
DV8	348-9172-030		X		SAE-16				X	
DVA4			X		1" NPT					X
DVA8			X		SAE-16					X
DX4	348-9172-039		X		1" NPT			X		
DX8	348-9172-040		X		SAE-16			X		
MA4	348-9172-005			X	1" NPT	X				
MA8	348-9172-006			X	SAE-16	X				
MB4	348-9172-081			X	1" NPT		X			
MB8	348-9172-082			X	SAE-16		X			
MV4				X	1" NPT				X	
MV8				X	SAE-16				X	
MVA4				X	1" NPT					X
MVA8				X	SAE-16					X
MX4	348-9172-058			X	1" NPT			X		
MX8	348-9172-059			X	SAE-16			X		
SA4	348-9171-002	X			1" NPT	X				
SA8	348-9171-003	X			SAE-16	X				
SB4	348-9171-007	X			1" NPT		X			
SB8	348-9171-017	X			SAE-16		X			
SV4	348-9171-018	X			1" NPT				X	
SV8	348-9171-016	X			SAE-16				X	
SVA4		X			1" NPT					X
SVA8		X			SAE-16					X
SX4		X			1" NPT	X		X		
SX8	348-9101-083	X			SAE-16	X		X		

Hi-Boy Work Sections

Part Number SDV70	Replacement for	3 Way 3 Position hold in neutral	4 Way 3 Position hold in neutral	4 Way 3 Position float in neutral	Port Size	Spring Return	3 Position Detent	Metering Hydraulic Remote	Metering Air Shift	On/Off Air Shift
HDA4	348-9172-008		X		1" NPT	X				
HDA8	348-9172-009		X		SAE-16	X				
HDB4	348-9172-013		X		1" NPT		X			
HDB8	348-9172-014		X		SAE-16		X			
HDV4	348-9172-020		X		1" NPT				X	
HDV8	348-9172-021		X		SAE-16				X	
HDVA4			X		1" NPT					X
HDVA8			X		SAE-16					X
HDX4	348-9172-175		X		1" NPT			X		
HDX8	348-9172-038		X		SAE-16			X		
HMA4	348-9172-011			X	1" NPT	X				
HMA8	348-9172-012			X	SAE-16	X				
HMB4	348-9172-062			X	1" NPT		X			
HMB8	348-9172-063			X	SAE-16		X			
HMV4	348-9172-126			X	1" NPT				X	
HMV8	348-9172-066			X	SAE-16				X	
HMVA4				X	1" NPT					X
HMVA8				X	SAE-16					X
HMX4	348-9172-072			X	1" NPT			X		
HMX8	348-9172-068			X	SAE-16			X		
HSA4	348-9171-005	X			1" NPT	X				
HSA8	348-9171-006	X			SAE-16	X				
HSB4	348-9172-060	X			1" NPT		X			
HSB8	348-9172-061	X			SAE-16		X			
HSV4		X			1" NPT				X	
HSV8		X			SAE-16				X	
HSVA4		X			1" NPT					X
HSVA8		X			SAE-16					X
HSX4		X			1" NPT	X		X		
HSX8		X			SAE-16	X		X		

Outlet - Coding Table

SDV70 - TR - 5 5

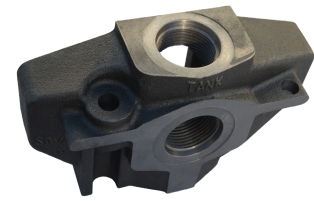
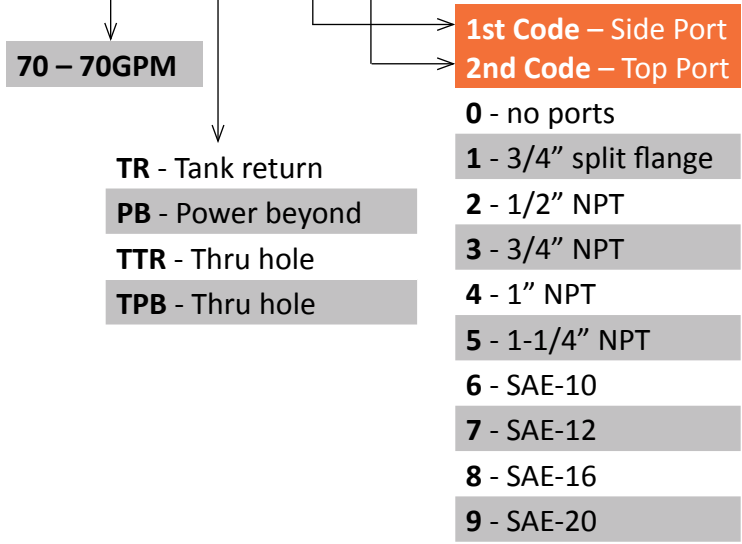

Tank Return

Part Number	Replacement for	Side Port	Top Port
SDV70-TR55	348-9176-001	1-1/4" NPT	1-1/4" NPT
SDV70-TR99	348-9176-002	SAE-20	SAE-20
*SDV70-TTR99	348-9176-007	SAE-20	SAE-20

Note: * For 3500psi application

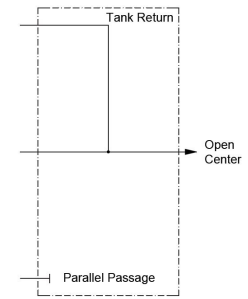

Power Beyond

Part Number	Replacement for	Side Port LP	Side Port HP	Top Port LP	Top Port HP
SDV70-PB09	348-9176-005	no port	no port	SAE-20	SAE-20
SDV70-PB55	348-9176-003	1-1/4" NPT	1-1/4" NPT	1-1/4" NPT	1-1/4" NPT
SDV70-PB90	348-9176-004	SAE-20	SAE-20	no port	no port
SDV70-PB99	348-0176-012	SAE-20	SAE-20	SAE-20	SAE-20
*SDV70-TPB99	348-9176-008	SAE-20	SAE-20	SAE-20	SAE-20

Note: * For 3500psi application

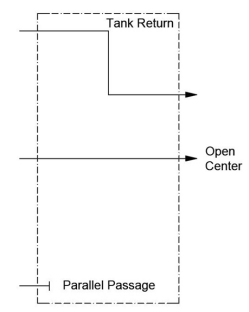

Stud Kits



Part Number	Replacement for
SDV70-SK-1	391-1873-053
SDV70-SK-2	391-1873-054
SDV70-SK-3	391-1873-055
SDV70-SK-4	391-1873-056
SDV70-SK-5	391-1873-057
SDV70-SK-6	391-1873-058
SDV70-SK-7	391-1873-059
SDV70-SK-8	391-1873-060

TSK studs - torque 75ft. lbs. (900in. lbs.)

Thru Hole Stud Kits



Part Number	Replacement for
SDV70-TSK-1	391-1873-138
SDV70-TSK-2	391-1873-139
SDV70-TSK-3	391-1873-140
SDV70-TSK-4	391-1873-141
SDV70-TSK-5	391-1873-142
SDV70-TSK-6	391-1873-143
SDV70-TSK-7	391-1873-144
SDV70-TSK-8	391-1873-145

TSK studs - torque 75ft. lbs. (900in. lbs.)

Work Section Spool Actuator Kits

Part Number	Replacement for	Function
SDV70-K-200	391-1873-026	Spring return
SDV70-K201	391-1873-027	3 position detent
SDV70-K-209	391-1873-170	Metering hyd remote control
SDV70-K-213	391-1873-203	Metering air shift
SDV70-K-213A		Airshift on/off

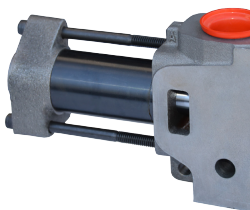

**Metering Hydraulic
Remote Control Kit**



**Metering
Air-Shift Kit**



**Air Shift
ON/OFF**

Spools

Part Number	Replacement for	Description
SDV70-SPL-11	391-1873-068	4 way/3 position, hold in neutral
SDV70-SPL-13	391-1873-072	4 way/3 position, float in neutral
SDV70-SPL-15	391-1873-076	3 way/3 position, hold in neutral

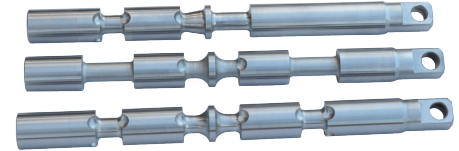

Seal Kits

Part Number	Replacement for	Kit	Kit Contains
SDV70-K-11	391-1873-040	Work section assembly kit	4 section seals
SDV70-K-12	391-1873-041	Work section repair kit	7 seals & 2 spool support rings

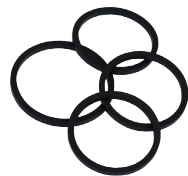

K-11

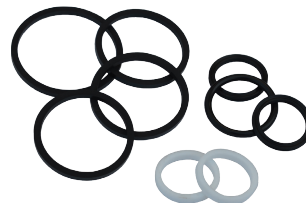

K-12

Handle Assembly

- includes linkage kit.

H style handles are for Hi-Boy sections with port relief valve on the handle side.

Part Number	Replacement for	Handle Length	Handle Style
SDV70-H-4	391-1873-097	8"	Standard
SDV70-H-6	391-1873-064	6"	H
SDV70-H-8	391-1873-065	8"	H
SDV70-H-10	391-1873-066	10"	H



Valve Accessories

Part Number	Replacement for	Description
SDV-AC	391-1873-010	Anti-cavitation check valve
SDV-PPRVS-1700	355-9109-027	Pilot port relief, set at 1700psi, 800-2500psi screw adjustable
SDV-PPRVS-2000	355-9109-027	Pilot port relief, set at 2000psi, 1000-2500psi screw adjustable
SDV-PRVAC	391-1873-006	Port relief valve with AC, set at 2500psi, 500-5000psi screw adjustable
SDV-PRVAC-1450	391-1873-006	Port relief valve with AC, set at 1450psi, 1000-2500psi screw adjustable
SDV-PRVP	391-1873-011	Port relief valve plug for Hi-boy
SDV-PRVS1	391-1873-344	Port relief valve, set at 1000psi, 500-1000psi screw adjustable
SDV-PRVS2	391-1873-345	Port relief valve, set at 2000psi, 1000-2500psi screw adjustable
SDV-PRVS3	391-1873-346	Port relief valve, set at 2500psi, 2500-3500psi screw adjustable
SDV-PRVS3-2900	355-1873-346	Port relief valve set at 2900psi, 2500-3500psi screw adjustable



SDV-PPRVS

SDV-PRVAC



SDV-PRVS



SDV-AC



SDV-PRVP



SDV- PRVAC performance

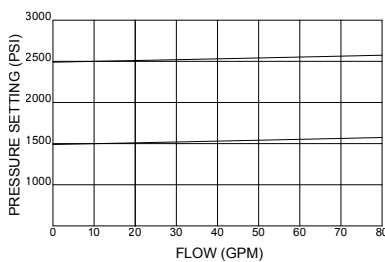

SDV- PRVS performance

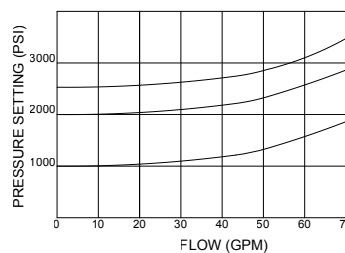

SDV-AC performance

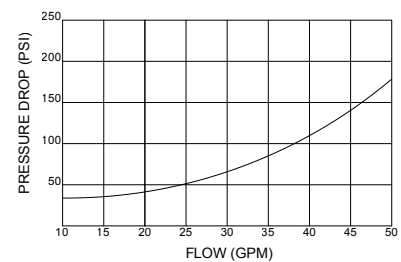

Work Port Plugs

NPT Plugs

Part Number	Size
SDV-DPL-75	3/4"
SDV-DPL-100	1"
SDV-DPL-125	1-1/4"
DPL-150	1-1/2"

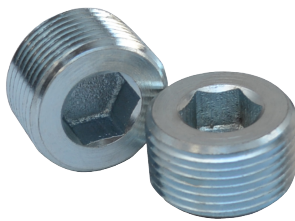

NPT Plugs

SAE Plugs - with O-rings

Part Number	Size
SDV-DPL-12	SAE-12
SDV-DPL-16	SAE-16
SDV-DPL-16/6	SAE16/SAE6
SDV-DPL-16/25	SAE-16/0.25"NPT
SDV-DPL-20	SAE-20

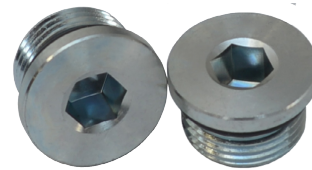

SAE Plugs

In-line Accessories

PRV series in-line pilot-operated relief valves max 60gpm/max 5000psi

Specifications:

Input Flow	60GPM
Max Operating Pressure	5000psi @ SAE port only
Operating Temperature	-40°C to +95°C (-40°F to 200°F)
Material	High strength cast iron and high grade steel
Filtration	ISO code 16/13 SAE Class 4 or better
Mounting Position	In-line. No restriction
Seal	Buna-N

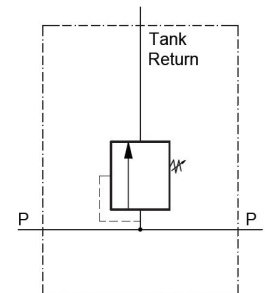
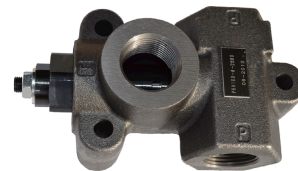

PRV Cartridges

Part Number	Replacement for	Description
PRVC60-A-2500	RP60A-2500	2500psi, adj 500-5000psi
PRVC60-A-3000	RP60A-3000	3000psi, adj 500-5000psi

Castings

Part Number	Replacement for	Port Size	Relief Setting	Casting Only
PRV12-A-2500	RPL-12-A-2500	SAE-12	2500psi screw adj. 500-3500psi	B-PRV12-A
PRV16-A-2500	RPL-16-A-2500	SAE-16	2500psi screw adj. 500-3500psi	B-PRV16-A
PRV75-A-2500	RPL-75-A-2500	3/4" NPT	2500psi screw adj. 500-3500psi	B-PRV75-A
PRV100-A-2500	RPL-100-A-2500	1" NPT	2500psi screw adj. 500-3500psi	B-PRV100-A

Castings with Cartridge

Part Number	Replacement for	Port Size	Relief Setting	Casting Only
PRV12-A-3000	RPL-12-A-3000	SAE-12	3000psi screw adj. 500-3500psi	B-PRV12-A
PRV16-A-3000	RPL-16-A-3000	SAE-16	3000psi screw adj. 500-3500psi	B-PRV16-A
PRV75-A-3000	RPL-75-A-3000	3/4" NPT	3000psi screw adj. 500-3500psi	B-PRV75-A
PRV100-A-3000	RPL-100-A-3000	1" NPT	3000psi screw adj. 500-3500psi	B-PRV100-A
PRV12-A-2500	RPL-12-A-2500	SAE-12	2500psi screw adj. 500-3500psi	B-PRV12-A
PRV16-A-2500	RPL-16-A-2500	SAE-16	2500psi screw adj. 500-3500psi	B-PRV16-A
PRV75-A-2500	RPL-75-A-2500	3/4" NPT	2500psi screw adj. 500-3500psi	B-PRV75-A
PRV100-A-2500	RPL-100-A-2500	1" NPT	2500psi screw adj. 500-3500psi	B-PRV100-A

Deceleration Valve

Part Number	Replacement for	Port Size	Description
DSCV-N75	355-9201-014	3/4" NPT	Deceleration speed control valve, cam operated, rated 40gpm@3500psi, max drain pressure 50psi.
DSCV-S16	355-9201-018	SAE16	Deceleration speed control valve, cam operated, rated 40gpm@3500psi, max drain pressure 50psi.

Pressure Compensated Flow Control Valve

Part Number	Port Size	Flow Range (gpm)	Relief adj. (psi)
PFCR51-1N50	1" NPT	0-50	1000-3000
PFCR51-50N16	1/2" NPT	0-16	
PFCR51-75N30	3/4" NPT	0-30	
PFCR51-10N16	SAE-10	0-16	
PFCR51-12N30	SAE-12	0-30	

Flow Control Valve

Part Number	Port Size	Flow Range (gpm)	No Relief
PFC51-1N50	1" NPT	0-50	n/a
PFC51-50N16	1/2" NPT	0-16	
PFC51-75N30	3/4" NPT	0-30	
PFC51-10N16	SAE-10	0-16	
PFC51-12N30	SAE-12	0-30	



SDV40 Competitors Interchange Quick Reference

Inlets

Part Number	DVA/DVG	TDN
SDV40-A44	DVA20-A44	347-9175-001
SDV40-A77	DVG20-A77	347-9175-004
SDV40-A88	DVA20-A88	347-9175-002

MRV & MRV Plug

Part Number	DVA/DVG	TDN
SDV40-MRV	DVA20-MRV	391-1873-001
SDV40-MRV-2200	DVA20-MRV	391-1873-001
SDV40-MRV-2500	DVA20-MRV	391-1873-001
SDV40-HMRV	DVG20-HMRV	391-1873-128
SDV40-HMRV-2600	DVG20-HMRV	391-1873-128
SDV40-MRVP	DVA20-MRVP	391-1873-002

Mid-Inlet

Part Number	DVA/DVG	TDN
SDV40-CFA30	DVA20-CFA30	347-9174-003
SDV40-CFA70	DVA20-CFA70	347-9174-004
SDV40-SFA30	DVA20-SFA30	347-9174-001
SDV40-SFA70	DVA20-SFA70	347-9174-002

Outlets

Part Number	DVA/DVG	TDN
SDV40-TR44	DVA20-TR44	347-9176-001
SDV40-TR50	DVA20-TR50	347-9176-501
SDV40-TR88	DVA20-TR88	347-9176-002
SDV40-TTR88	DVG20-TTR88	347-9176-007
SDV40-TTR90	DVG20-TTR90	347-9176.024
SDV40-PB44	DVA20-PB44	347-9176-003
SDV40-PB08	DVA20-PB08	347-9176-005
SDV40-PB80	DVA20-PB80	347-9176-004
SDV40-PB88	DVA20-PB88	347-9176-007
SDV40-TPB88	DVG20-TPB88	N/A

Work Section

Part Number	DVA/DVG	TDN
SDV40-DA3	DVA20-DA3	347-9172-002
SDV40-DA7	DVA20-DA7	347-9172-003
SDV40-DB3	DVA20-DB3	347-9172-026
SDV40-DB7	DVA20-DB7	347-9172-027
SDV40-DV3	DVA20-DV3	347-9172-033
SDV40-DVA3	N/A	N/A
SDV40-DV7	DVA20-DV7	347-9172-034
SDV40-DVA7	N/A	N/A
SDV40-DX3	DVA20-DX3	347-9172-043
SDV40-DX7	DVA20-DX7	347-9172-044
SDV40-MA3	DVA20-MA3	347-9172-005
SDV40-MA7	DVA20-MA7	347-9172-006
SDV40-MB3	DVA20-MB3	347-9172-039
SDV40-MB7	DVA20-MB7	347-9172-040
SDV40-MV3	DVA20-MV3	N/A
SDV40-MVA3	N/A	N/A
SDV40-MV7	DVA20-MV7	347-9102-896
SDV40-MVA7	N/A	N/A
SDV40-MX3	DVA20-MX3	347-9172-062
SDV40-MX7	DVA20-MX7	347-9172-063
SDV40-SA3	DVA20-SA3	347-9171-002
SDV40-SA7	DVA20-SA7	347-9171-003
SDV40-SB3	DVA20-SB3	347-9171-007
SDV40-SB7	DVA20-SB7	347-9171-008
SDV40-SV3	DVA20-SV3	347-9101-129
SDV40-SVA3	N/A	N/A
SDV40-SV7	DVA20-SV7	347-9171-018
SDV40-SVA7	N/A	N/A
SDV40-SX3	N/A	N/A
SDV40-SX7	DVA20-SX7	347-9101-161

Work Section Hi-Boy

Part Number	DVA/DVG	TDN
SDV40-HDA3	DVA20-HA355	347-9172-008
SDV40-HDA7	DVA20-HA755	347-9172-009
SDV40-HDA7-PA	N/A	347-9102-531
SDV40-HDA7-PB	N/A	347-9112-113
SDV40-HDB3	DVA20-HB355	347-9172-017
SDV40-HDB7	DVA20-HB755	347-9172-018
SDV40-HDV3	DVA20-HV355	347-9172-024
SDV40-HDVA3	N/A	N/A
SDV40-HDV7	DVA20-HV755	347-9172-025
SDV40-HDVA7	N/A	N/A
SDV40-HDX3	DVA20-HX355	347-9172-045
SDV40-HDX7	DVA20-HX755	347-9172-046
SDV40-HMA3	DVA20-LA355	347-9172-011
SDV40-HMA7	DVA20-LA755	347-9172-012
SDV40-HMB3	DVA20-LB355	347-9172-077
SDV40-HMB7	DVA20-LB755	347-9172-078
SDV40-HMV3	DVA20-LV355	N/A
SDV40-HMVA3	N/A	N/A
SDV40-HMV7	DVA20-LV755	N/A
SDV40-HMVA7	N/A	N/A
SDV40-HMX3	DVA20-LX355	347-9172-072
SDV40-HMX7	DVA20-LX755	347-9172-073
SDV40-HSA3	DVA20-JA305	347-9171-005
SDV40-HSA7	DVA20-JA705	347-9171-006
SDV40-HSB3	DVA20-JB305	347-9171-010
SDV40-HSB7	DVA20-JB705	347-9171-012
SDV40-HSV3	DVA20-JV305	N/A
SDV40-HSVA3	N/A	N/A
SDV40-HSV7	DVA20-JV705	347-9171-011
SDV40-HSVA7	N/A	N/A
SDV40-HSX3	DVA20-JX355	N/A
SDV40-HSX7	DVA20-JX755	N/A

Handles

Part Number	DVA/DVG	TDN
SDV40-H-4	DV20-H-4	391-1873-094
SDV40-H-6	DV20-H-6	391-1873-061
SDV40-H-8	DV20-H-8	391-1873-062
SDV40-H-10	DV20-H-10	391-1873-063

Stud Kits

Part Number	DVA/DVG	TDN
SDV40-SK-1	DVA20-SK-1	391-1873-045
SDV40-SK-2	DVA20-SK-2	391-1873-046
SDV40-SK-3	DVA20-SK-3	391-1873-047
SDV40-SK-4	DVA20-SK-4	391-1873-048
SDV40-SK-5	DVA20-SK-5	391-1873-049
SDV40-SK-6	DVA20-SK-6	391-1873-050
SDV40-SK-7	DVA20-SK-7	391-1873-051
SDV40-SK-8	DVA20-SK-8	391-1873-052

Stud Kits

Part Number	DVA/DVG	TDN
SDV40-TSK-1	DVG20-TSK-1	391-1873-129
SDV40-TSK-2	DVG20-TSK-2	391-1873-130
SDV40-TSK-3	DVG20-TSK-3	391-1873-131
SDV40-TSK-4	DVG20-TSK-4	391-1873-132
SDV40-TSK-5	DVG20-TSK-5	391-1873-133
SDV40-TSK-6	DVG20-TSK-6	391-1873-134
SDV40-TSK-7	DVG20-TSK-7	391-1873-135
SDV40-TSK-8	DVG20-TSK-8	391-1873-136

Spools

Part Number	DVA/DVG	TDN
SDV40-SPL-1	DV20-SPL-1	391 1873 067
SDV40-SPL-3	DV20-SPL-3	391 1873 071
SDV40-SPL-5	DV20-SPL-5	391 1873 075

Spool Actuation Kits

Part Number	DVA/DVG	TDN
SDV40-K-100	DV20-K-100	391-1873-019
SDV40-K-101	DV20-K-101	391-1873-020
SDV40-K-109	DV20-K-109	391-1873-173
SDV40-K-113	DV20-K-113	391-1873-206
SDV40-K-113A	N/A	N/A

Seal Kits

Part Number	DVA/DVG	TDN
SDV40-K-1	DV20-K-1	391-1873-035
SDV40-K-2	DV20-K-2	391-1873-036

SDV70 Competitors Interchange Quick Reference

Inlets

Part Number	DVA/DVG	TDN
SDV70-A44	DVA35-A44	348-9175-001
SDV70-A88	DVA35-A88	348-9175-005
SDV70-A98	DVA35-A98	348-9175-002

MRV & MRV Plug

Part Number	DVA/DVG	TDN
SDV70-MRV1	DVA35-MRV1	391-1873-003
SDV70-MRV2	DVA35-MRV2	391-1873-004
SDV70-HMRV	DVG35-HMRV	391-1873-137
SDV70-MRVP	DVA35-MRVP	391-1873-005

Mid-Inlet

Part Number	DVA/DVG	TDN
SDV70-CFA40	DVA35-CFA40	348-9174-003
SDV70-CFA80	DVA35-CFA80	348-9174-004
SDV70-SFA40	DVA35-SFA40	348-9174-001
SDV70-SFA80	DVA35-SFA80	348-9174-005

Outlets

Part Number	DVA/DVG	TDN
SDV70-TR55	DVA35-TR55	348-9176-001
SDV70-TR99	DVA35-TR99	348-9176-002
SDV70-TTR99	DVG35-TTR99	348-9176-007
SDV70-PB55	DVA35-PB55	348-9176-003
SDV70-PB09	DVA35-PB09	348-9176-005
SDV70-PB90	DVA35-PB90	348-9176-004
SDV70-PB99	DAV35-PB99	348-9176-012
SDV70-TPB99	DVG35-TPB99	348-9176-008

Work Section

Part Number	DVA/DVG	TDN
SDV70-DA4	DVA35-DA4	348-9172-002
SDV70-DA8	DVA35-DA8	348-9172-003
SDV70-DB4	DVA35-DB4	348-9172-022
SDV70-DB8	DVA35-DB8	348-9172-023

Part Number	DVA/DVG	TDN
SDV70-DV4	DVA35-DV4	348-9172-029
SDV70-DV8	DVA35-DV8	348-9172-030
SDV70-DX4	DVA35-DX4	348-9172-039
SDV70-DX8	DVA35-DX8	348-9172-040
SDV70-MA4	DVA35-MA4	348-9172-005
SDV70-MA8	DVA35-MA8	348-9172-006
SDV70-MB4	DVA35-MB4	348-9172-081
SDV70-MB8	DVA35-MB8	348-9172-082
SDV70-MV4	DVA35-MV4	N/A
SDV70-MV8	DVA35-MV8	348-9102-651
SDV70-MX4	DVA35-MX4	348-9172-058
SDV70-MX8	DVA35-MX8	348-9172-059
SDV70-SA4	DVA35-SA4	348-9171-002
SDV70-SA8	DVA35-SA8	348-9171-003
SDV70-SB4	DVA35-SB4	348-9171-007
SDV70-SB8	DVA35-SB8	348-9171-017
SDV70-SV4	DVA35-SV4	348-9171-018
SDV70-SV8	DVA35-SV8	348-9171-016
SDV70-SX4	DVA35-SX4	N/A
SDV70-SX8	DVA35-SX8	348-9101-083

Work Section Hi Boy

Part Number	DVA/DVG	TDN
SDV70-HDA4	DVA35-HA455	348-9172-008
SDV70-HDA8	DVA35-HA855	348-9172-009
SDV70-HDB4	DVA35-HB455	348-9172-013
SDV70-HDB8	DVA35-HB855	348-9172-014
SDV70-HDV4	DVA35-HV455	348-9172-020
SDV70-HDV8	DVA35-HV855	348-9172-021
SDV70-HDX4	N/A	N/A
SDV70-HDX8	DVA35-HX855	348-9172-038
SDV70-HMA4	DVA35-LA455	348-9172-011
SDV70-HMA8	DVA35-LA855	348-9172-012

Part Number	DVA/DVG	TDN
SDV70-HMB4	DVA35-LB455	348-9172-062
SDV70-HMB8	DVA35-LB855	348-9172-063
SDV70-HMV4	N/A	N/A
SDV70-HMV8	DVA35-LV855	348-9172-066
SDV70-HMX4	DVA35-LX455	348-9172-072
SDV70-HMX8	DVA35-LX855	348-9172-068
SDV70-HSA4	DVA35-JA405	348-9171-005
SDV70-HSA8	DVA35-JA805	348-9171-006
SDV70-HSB4	DVA35-JB405	348-9171-009
SDV70-HSB8	DVA35-JB805	348-9171-010
SDV70-HSV4	N/A	N/A
SDV70-HSV8	DVA35-JV805	348-9101-107
SDV70-HSX4	N/A	N/A
SDV70-HSX8	N/A	N/A

Handles

Part Number	DVA/DVG	TDN
SDV70-H-4	DV35-H-4	391-1873-097
SDV70-H-6	DV35-H-6	391-1873-064
SDV70-H-8	DV35-H-8	391-1873-065
SDV70-H-10	DV35-H-10	391-1873-066

Stud Kits

Part Number	DVA/DVG	TDN
SDV70-SK-1	DVA35-SK-1	391-1873-053
SDV70-SK-2	DVA35-SK-2	391-1873-054
SDV70-SK-3	DVA35-SK-3	391-1873-055
SDV70-SK-4	DVA35-SK-4	391-1873-056
SDV70-SK-5	DVA35-SK-5	391-1873-057
SDV70-SK-6	DVA35-SK-6	391-1873-058
SDV70-SK-7	DVA35-SK-7	391-1873-059
SDV70-SK-8	DVA35-SK-8	391-1873-060

Thru HoleStud Kits

Part Number	DVA/DVG	TDN
SDV70-TSK-1	DVG35-TSK-1	391-1873-138
SDV70-TSK-2	DVG35-TSK-2	391-1873-139
SDV70-TSK-3	DVG35-TSK-3	391-1873-140
SDV70-TSK-4	DVG35-TSK-4	391-1873-141
SDV70-TSK-5	DVG35-TSK-5	391-1873-142
SDV70-TSK-6	DVG35-TSK-6	391-1873-143
SDV70-TSK-7	DVG35-TSK-7	391-1873-144
SDV70-TSK-8	DVG35-TSK-8	391-1873-145

Spools

Part Number	DVA/DVG	TDN
SDV70-SPL-11	DV35-SPL-11	391-1873-068
SDV70-SPL-13	DV35-SPL-13	391-1873-072
SDV70-SPL-15	DV35-SPL-15	391-1873-076

Spool Actuation Kits

Part Number	DVA/DVG	TDN
SDV70-K-200	DV35-K-200	391-1873-026
SDV70-K-201	DV35-K-201	391-1873-027
SDV70-K-209	DV35-K-209	391-1873-170
SDV70-K-213	DV35-K-213	391-1873-203

Seal Kits

Part Number	DVA/DVG	TDN
SDV70-K-11	DV35-K-11	391-1873-040
SDV70-K-12	DV35-K-12	391-1873-041

Accessories Competitors Interchange Quick Reference

Port Relief Valves

Part Number	DVA/DVG	TDN
SDV-AC	DV-AC	391-1873-010
SDV-PPRVP	DV-PPRVP	391-1873-911
SDV-PPRVS-1700	DV-PPRVS-1700	355-9109-027
SDV-PPRVS-2000	DV-PPRVS-2000	355-9109-027
SDV-PRVAC	DV-PRVAC	391-1873-006
SDV-PRVAC-1450	DV-PRVAC	391-1873-006
SDV-PRVP	DV-PRVP	391-1873-011
SDV-PRVS1	DV-PRVS1	391-1873-344
SDV-PRVS2	DV-PRVS2	391-1873-345
SDV-PRVS3	DV-PRVS3	391-1873-346
SDV-PRVS3-2900	DV-PRVS3-2900	391-1873-346

Plugs

Part Number	DVA/DVG	TDN
SDV-DPL- 12	DV-DPL- 12	391-1873-016
SDV-DPL- 16	DV-DPL- 16	391-1873-017
SDV-DPL- 16/25	DV-DPL- 16/25	391-1873-910
SDV-DPL/6	DV-DPL-16/6	N/A
SDV-DPL- 20	DV-DPL- 20	391-1873-018
SDV-DPL- 75	DV-DPL- 75	391-1873-013
SDV-DPL- 100	DV-DPL- 100	391-1873-014
SDV-DPL- 125	DV-DPL- 125	391-1873-015

PRV Casting Only

Part Number	DVA/DVG	TDN
B-PRV12-A	RPL-12	N/A
B-PRV16-A	RPL-16	N/A
B-PRV75-A	RPL-75	N/A
B-PRV100-A	RPL-100	N/A

PRV Cartridges

Part Number	DVA/DVG	TDN
PRVC60-A-2500	RP60A-2500	N/A
PRVC60-A-3000	RP60A-3000	N/A

PRV Assemblies

Part Number	DVA/DVG	TDN
PRV12-A-2500	RPL-12-A-2500	N/A
PRV12-A-3000	RPL-12-A-3000	N/A
PRV16-A-2500	RPL-16-A-2500	N/A
PRV16-A-3000	RPL-16-A-3000	N/A
PRV75-A-2500	RPL-75-A-2500	N/A
PRV75-A-3000	RPL-75-A-3000	N/A
PRV100-A-2500	RPL-100-A-2500	N/A
PRV100-A-3000	RPL-100-A-3000	N/A

Pressure Compensated Flow Control Valves

Part Number	DVA/DVG	TDN
PFCR51-10N16	FCR51-10N	N/A
PFCR51-12N30	FCR51-12N	N/A
PFCR51-50N16	FCR51-25N	N/A
PFCR51-75N30	FCR51-34N	N/A
PFCR51-1N50	N/A	N/A
PFC51-10N16	FCR51-10N	N/A
PFC51-12N30	FCR51-12N	N/A
PRC51-50N16	FCR51-25N	N/A
PFC51-75N30	FCR51-34N	N/A
PFC51-1N50	N/A	N/A

Deceleration Speed Control Valves

Part Number	DVA/DVG	TDN
DSCV-N75	DDVC-N75	355-9201-014

Valve Assembly Form

Company:	Phone:
Address:	Email:
Main Contact:	Customer Part Number:

Model: SDV40 SDV70 **Assembly Direction:** Left Right

Inlet	Outlet	Handles
<p>Main Relief: Yes <input type="checkbox"/> No <input type="checkbox"/> Set at _____ PSI</p> <p>Porting (SAE - NPT) Top: Type _____ Size _____ Side: Type _____ Size _____</p>	<p>Type: Tank Return <input type="checkbox"/> Power Beyond <input type="checkbox"/> Thru Hole <input type="checkbox"/> Thru Hole <input type="checkbox"/></p> <p>Porting (SAE - NPT) Top: Type _____ Size _____ Side: Type _____ Size _____ Top/Side: Type _____ Size _____</p>	<p>Yes <input type="checkbox"/> No <input type="checkbox"/></p> <p>(Please Circle Number)</p> <p>Standard handles at section number: 1 2 3 4 5 6 7 8</p> <p>H handles at section number: 1 2 3 4 5 6 7 8</p>

Work Sections

	1	2	3	4	5	6	7	8
Parallel								
Series								
Double Acting 4 Way/ 3 Pos								
Single Acting 3 Way/3 Pos								
Cylinder Spool								
Motor Spool								
A/B Port Size								

Spool Actuator

	1	2	3	4	5	6	7	8
Spring Return								
3 Pos Detent								
Hyd. Remote Meter								
Hyd. Pilot ON/OFF								
Air Remote Meter								
Solenoid 12VDC								
Other								

Hi-boy Port Accessories

	1	2	3	4	5	6	7	8
Anti-Cavitation	A							
	B							
PRVAC _____ PSI	A							
	B							
PRVS _____ PSI	A							
	B							
Plugged _____ PSI	A							
	B							

Mid-Inlets

	1	2	3	4	5	6	7	8
Split Flow								
Comb Flow								
Main R/V								
Main R/V Plug								
Port Size SAE <input type="checkbox"/> NPT <input type="checkbox"/>								

Comments:

Warranty Policy

The Hyflow Controls sectional direction control valve and other parts covered in this catalog are warranted for a period of (1) one year from the date of installation against any defect in material and workmanship which existed at the time of sale by Hyflow Controls Inc., according to the following provisions, subject to the requirements that the sectional direction control valve must be used only in accordance with catalog and package instructions.

If during the warranty period the sectional direction control valve fails due to a defect in any part in material or workmanship that existed at the time of the sale by Hyflow Controls Inc., the defective part will be repaired or replaced, at the discretion of Hyflow Controls Inc., at no charge, if the defective part is returned to Hyflow Controls Inc. with transportation prepaid. Authorization from your sales representative is required to initiate the warranty.

WARNING: The above warranty shall terminate if any alterations or repairs are made to the sectional direction control valve other than at Hyflow Controls Inc.

The foregoing warranty is in lieu of all other obligations and liabilities, including negligence and all warranties of merchantability and suitability, expressed or implied, and state Hyflow Controls' entire and exclusive liability and buyer's exclusive remedy for any claim of damages in connection with the sale, repair or replacement of the above goods, their design, installation or operation. Hyflow Controls Inc. will in no event be liable for any direct, indirect, special, incidental or consequential damages whatsoever, and our liability under no circumstances will exceed the contract price for the goods for which liability is claimed.

Hyflow Controls Inc. is not liable for any repair related cost incurred to the buyer at any time if the repair is conducted by the buyer without written authorization from Hyflow Controls Inc.



Hyflow Controls

2134 S. Green Privado

Ontario, CA 91761

Tel: 1-866-865-8889

sales@hyflow-controls.com

www.hyflow-controls.com